

Aero



AERO
JORG KURTEN - MADE BY JORG
BRAND LOYALTY, DEN BOSCH (NL)

Cross-section / mounting



AERO 2X MR16 DEGREE

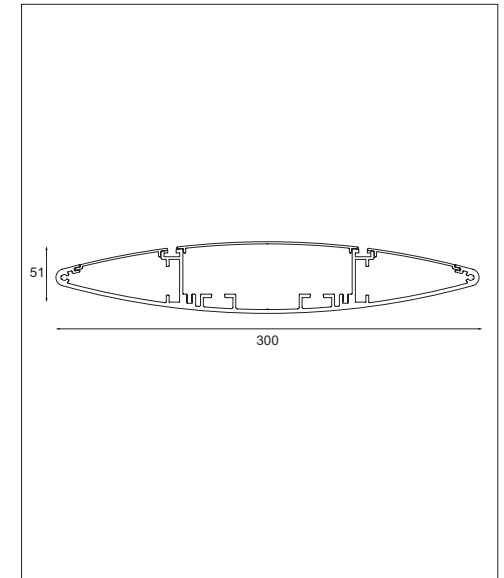



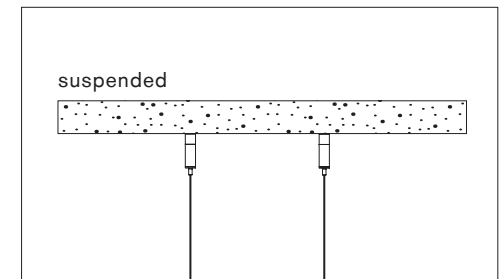



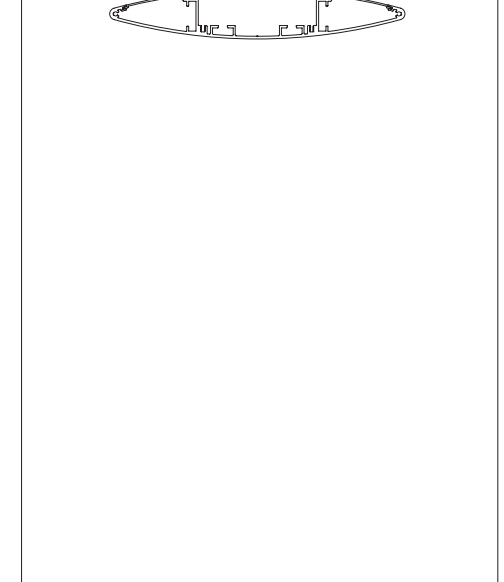



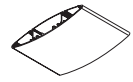
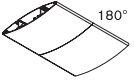
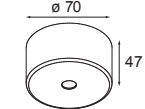
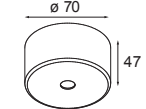



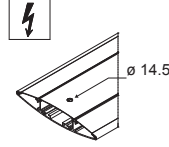

AERO TL5 FLUOLINE DOWN 2X 54W

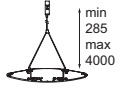

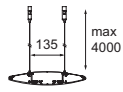
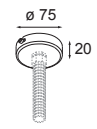
AERO TL5 1X 28W BAP DO



Aero Components

<p>Profile Variation ></p>	<p>profile alu/m</p>  <p>93100007 93100007 + 93100108</p>	<p>Connections ></p>	<p>connection 180°</p>  <p>93100050</p>	<p>connection box for transparent cable 3x 1.5mm² alu</p>  <p>93002151 93003151 93002951 93002151 + 93002053</p>	<p>connection box for transparent cable 5x 1.5mm² alu</p>  <p>93002251 93003251 93003951 93002251 + 93002053</p>	<p>transparent cable/m 3x 1.5mm²</p>  <p>93002152</p>	<p>transparent cable/m 5x 1.5mm²</p>  <p>93002252</p>
<p>connection 135°</p>  <p>93100055</p>	<p>connection 90°</p>  <p>93100060</p>	<p>Endplates ></p>	<p>endplate</p>  <p>93100181 93100181 + 93100188</p>	<p>hole for power supply</p>  <p>93000100 new</p>			
<p>wall support</p>  <p>93100160</p>	<p>Fixation/ Mounting ></p>	<p>suspension twin 4m</p>  <p>min 285 max 4000 93000145 93000145 + 93000146</p>	<p>hinged suspension 4m</p>  <p>93000147 93009147 93000147 + 93000149</p>				
<p>suspension set 4m</p>  <p>135 max 4000 93000150 93000150 + 93000158</p>	<p>Electrical supply ></p>	<p>connection box</p>  <p>93000151 93003351 93000951 93000151 + 93000153</p>	<p>flexible</p>  <p>1m 93000152 /m 93000252</p>				
<p>power feed tube 1m</p>  <p>93000156 93003156 93000856 93000156 + 93000157</p>	<p>power feed tube/m</p>  <p>93000256 93003256 93000956 93000256 + 93000157</p>	<p>power feed kit 2m (transparent cable) 3x 1.5mm² alu</p>  <p>93002003 93003203 93002903 93002003 + 93002053</p>	<p>power feed kit 2m (transparent cable) 5x 1.5mm² alu</p>  <p>93002005 93003205 93002905 93002005 + 93002053</p>				

Aero Linear custom made modules

TL5 HO side up

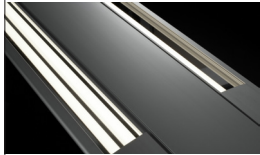

	non-dim	1-10V	DSI	Pushdim/Dali	emergency pack 3h	mod / asym / sym
2x 24W	93105022	96105022	97105022	98105022	-	620/620/620
2x 39W	93105037	96105037	97105037	98105037	93101012	920/920/920
2x 54W	93105052	96105052	97105052	98105052	93101012	1220/1220/1220
2x 49W	93105049	96105049	97105049	98105049	-	1520/1520/1520



T16 G5

MR16 degree down black



	Dim R, L, C	Dali	mod / asym / sym
1x 50W	93100190	98100190	140/260/380
2x 50W	93100191	98100191	280/400/520

ral ... +93108051

QR-CBC 51 Gu 5.3

h 359° v -15°/+15°

h up 10

HIPAR-C16 degree down black



	non-dim	mod / asym / sym
1x 20W	93103117	140/300/460
1x 35W	93103119	140/300/460
2x 20W	93103118	280/550/600
2x 35W	93103120	280/550/600

eco ral ... +93108051

HIPAR-C16 Gx10

h 359° v -15°/+15°

FLUORESCENT

HALOGEN 12V

DISCHARGE

Aero Supplements



article ral supplements

93108050 ral set up charge

article supplements

93112000 suppl. extra circuit /m



AERO
MEC DESIGN INTERNATIONAL CORPORATION
MED DESIGN INTERNAIONAL RELOCATION PROJECT 2009, TOKYO (JAPAN)