

# Freeway



**FREEWAY**  
D+Z ARCHITECTEN+PROJECTMANAGERS  
NORWEGIAN EMBASSY, DEN HAAG (NL)

## Cross-section / mounting



FREEWAY LED DEGREE DOWN

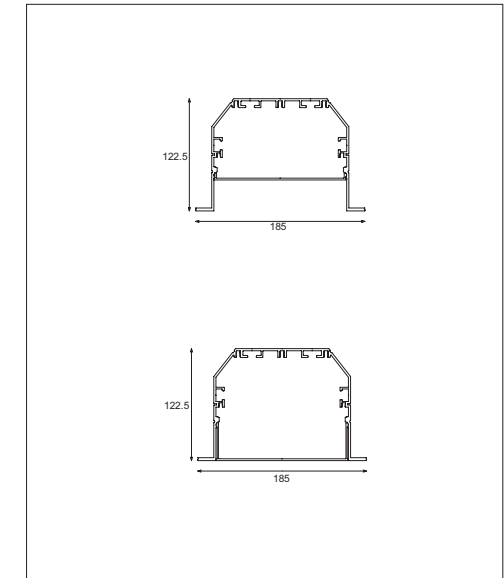

FREEWAY TL5 POLY DOWN COVER SUPERIOR

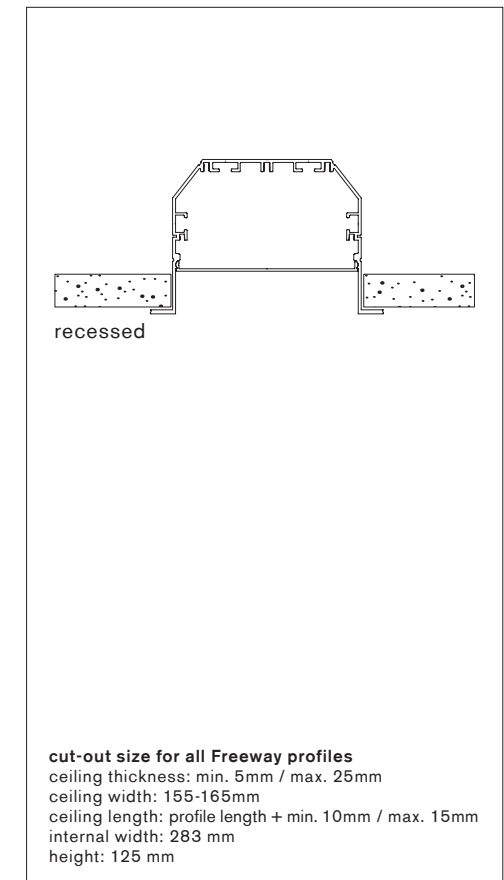

### Freeway Components

**Profile Variation >**

profile alu/m, cover black



93180002  
93180002 + 93180108

profile alu/m, cover alu



93180005  
93180005 + 93180108

profile alu/m, cover superior black



93180012  
93180012 + 93180110

profile alu/m, cover superior alu



93180015  
93180015 + 93180110

**Connections >**

connection 180°

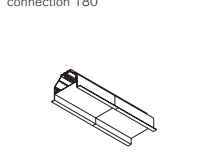

93180050

connection 135°



93180055

connection 90°



93180060

**Endplates >**

endplate

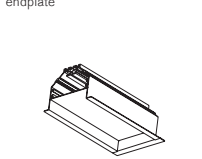

93180181  
93180181 + 93180188

recessed endplate

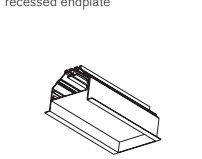

93180182  
93180182 + 93180188

**Fixation/ Mounting >**

suspension bracket

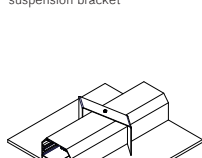

93180999

surface fixation hole



hole ø 6.5

93000999

### Freeway Linear custom made modules

**LED 1100lm**

	3000K non-dim	3000K Dali	mod / asym / sym
1x warm white	93187183	98187183	140/371/602

! not possible with cover superior  
! 4000K on request



eco

**LED 2000lm**

	2700K non-dim	2700K Dali	mod / asym / sym
1x warm white	93187283	98187283	140/396/652

! not possible with cover superior  
! 4000K on request



eco

**LED degree down black**

	reflector	2700K non-dim	2700K 1-10V/ Pushdim	2700K Dali	mod / asym / sym
1x warm white	medium	93187132	96187132	98187132	73/293/512
2x warm white	medium	93187232	96187232	98187232	146/366/585
1x warm white	flood	93187133	96187133	98187133	73/293/512
2x warm white	flood	93187233	96187233	98187233	146/366/585

! 3000K, 3500K, 4000K on request  
LED Array v -25°/+25° h up 28 / h down 8

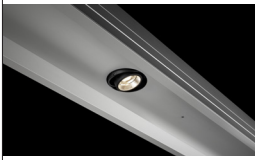

eco ral ...+93188051

**LED emergency pack 3h down 1,8Ah NiMH 275mA alu**

	non-dim	mod / asym / sym
1x 1W	93181113	18/261/494

LED

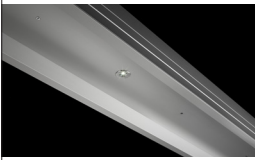

eco

**TL5 HE poly down**

	non-dim	1-10V	DSI	Pushdim/Dali	emergency pack 3h	mod / asym / sym
2x 14W	93185114	96185114	97185114	98185114	-	580/635/690
2x 21W	93185121	96185121	97185121	98185121	93181011	880/935/990
2x 28W	93185128	96185128	97185128	98185128	93181011	1180/1235/1290
2x 35W	93185135	96185135	97185135	98185135	93181011	1480/1535/1590

T16 G5

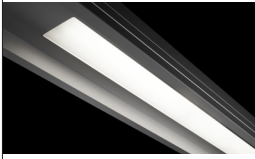

eco

LED

LED

FLUORESCENT

Freeway Linear custom made modules

Freeway Linear custom made modules

TL5 HO poly down

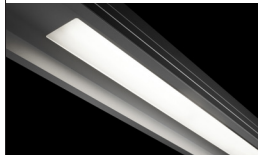

	non-dim	1-10V	DSI	Pushdim/Dali	emergency pack 3h	mod / asym / sym
2x 24W	93185122	96185122	97185122	98185122	-	580/635/690
2x 39W	93185137	96185137	97185137	98185137	93181012	880/935/990
2x 54W	93185152	96185152	97185152	98185152	93181012	1180/1235/1290
2x 49W	93185149	96185149	97185149	98185149	-	1480/1535/1590



T16 G5

MR16 LC down black



	Dim R, L, C	Dali	mod / asym / sym
1x 50W	93180316	98180316	75/255/440
2x 50W	93180416	98180416	150/330/510

ral ...+93188051

QR-CBC 51 Gu 5.3

h 359° v -25°/+25°

h down 30

TL5 HE bap down

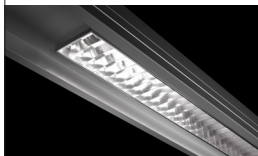

	non-dim	1-10V	DSI	Pushdim/Dali	emergency pack 3h	mod / asym / sym
1x 14W	93185814	96185814	97185814	98185814	-	635/690/745
1x 21W	93185821	96185821	97185821	98185821	93181011	935/990/1045
1x 28W	93185828	96185828	97185828	98185828	93181011	1235/1290/1345
1x 35W	93185835	96185835	97185835	98185835	93181011	1535/1590/1645
2x 14W	93185914	96185914	97185914	98185914	-	635/690/745
2x 21W	93185921	96185921	97185921	98185921	93181011	935/990/1045
2x 28W	93185928	96185928	97185928	98185928	93181011	1235/1290/1345
2x 35W	93185935	96185935	97185935	98185935	93181011	1535/1590/1645



T16 G5

h down 8

MR16 degree down black



	Dim R, L, C	Dali	mod / asym / sym
1x 50W	93180317	98180317	75/255/440
2x 50W	93180417	98180417	150/330/510

ral ...+93188051

QR-CBC 51 Gu 5.3

h 359° v -25°/+25°

MR16 k-1 down black

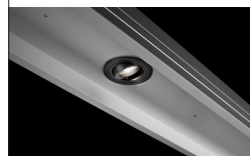

	Dim R, L, C	Dali	mod / asym / sym
1x 50W	93180198	98180198	90/270/450
2x 50W	93180199	98180199	220/400/580

QR-CBC 51 Gu 5.3

h 359° v -17°/+17°

TL5 HO bap down

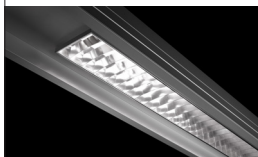

	non-dim	1-10V	DSI	Pushdim/Dali	emergency pack 3h	mod / asym / sym
1x 24W	93185822	96185822	97185822	98185822	-	635/690/745
1x 39W	93185837	96185837	97185837	98185837	93181012	935/990/1045
1x 54W	93185852	96185852	97185852	98185852	93181012	1235/1290/1345
1x 49W	93185849	96185849	97185849	98185849	-	1535/1590/1645
2x 24W	93185922	96185922	97185922	98185922	-	635/690/745
2x 39W	93185937	96185937	97185937	98185937	93181012	935/990/1045
2x 54W	93185952	96185952	97185952	98185952	93181012	1235/1290/1345
2x 49W	93185949	96185949	97185949	98185949	-	1535/1590/1645



T16 G5

h down 8

AR111 unit down black



	Dim R, L, C	Dali	mod / asym / sym
1x 50W	93180311	98180311	135/315/495
2x 50W	93180411	98180411	270/450/630

ral ...+93188055

QR-LP 111 G53

h 359° v -25°/+25°

HIPAR-C16 degree down black



	non-dim	mod / asym / sym
1x 20W	93183117	80/250/420
1x 35W	93183119	80/250/420
2x 20W	93183118	146/420/460
2x 35W	93183120	146/420/460

eco ral ...+93188051

HIPAR-C16 Gx10

h 359° v -25°/+25°



## Freeway Linear custom made modules

### CDM-T unit down black



	reflector	non-dim	mod / asym / sym
1x 35W	medium	93183272	135/360/585
1x 70W	medium	93183273	135/360/585
2x 35W	medium	93183274	270/720/720
2x 70W	medium	93183275	270/720/720

eco ral ... + 93188055

HIT-CE G12

h up 30

### CDM-TC unit down black

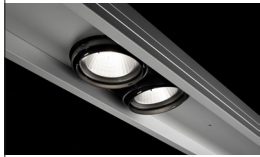

	reflector	non-dim	mod / asym / sym
1x 35W	flood	93183472	135/360/585
1x 70W	flood	93183473	135/360/585
2x 35W	flood	93183474	270/720/720
2x 70W	flood	93183475	270/720/720

h 359° v-15°/+15°

eco ral ... + 93188055

HIT-TC -CE G8.5

h 359° v-15°/+15°

DISCHARGE

## Freeway Supplements



article ral supplements  
93188050 ral set up charge



article supplements  
93183000 suppl. extra circuit /m

