

# Halfpipe



HALFPIPE  
DESIGN FRANCOIS HANNES  
TREESWIJKHOEVE, WAALRE (NL)

## Cross-section / mounting





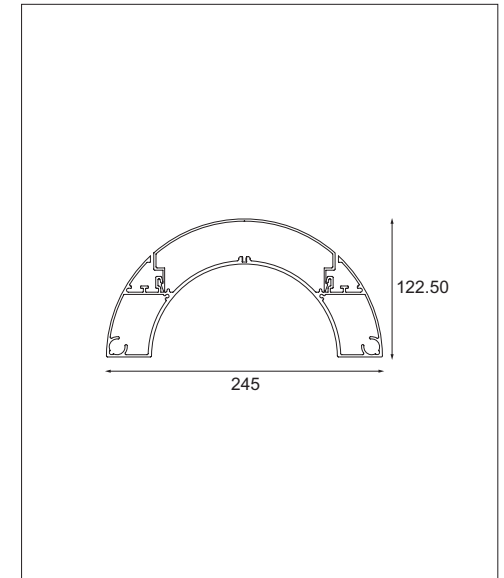



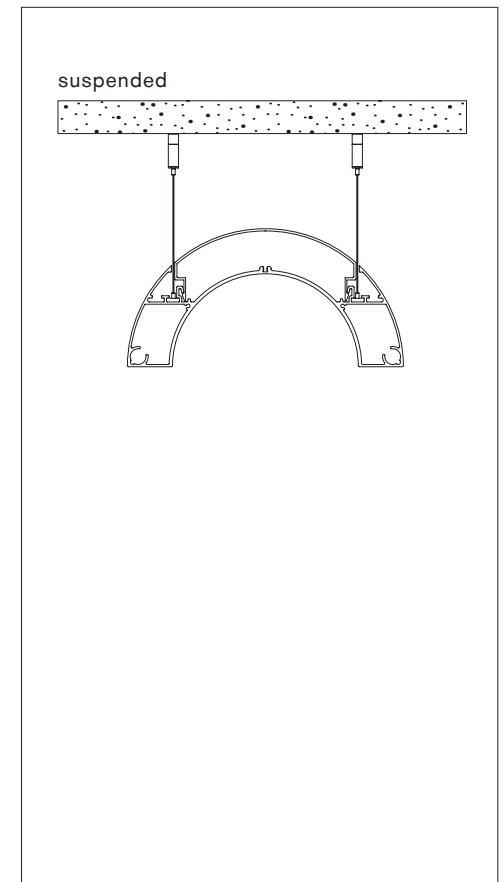

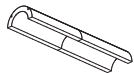
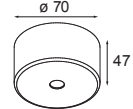

HALFPIPE 2X BOLSTER AR111

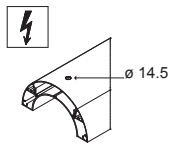
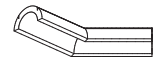
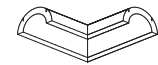
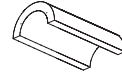
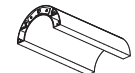

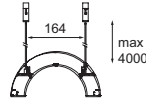
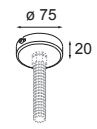
HALFPIPE FUSE 2X 54W

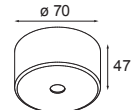

# Halfpipe Components

<p><b>Profile Variation &gt;</b></p>	<p>profile alu/m</p>  <p>93270005 93270005 + 93270108</p>	<p><b>Connections &gt;</b></p>	<p>connection 180°</p>  <p>93270050</p>	<p>connection box for transparent cable 5x 1.5mm² alu</p>  <p>93002251 93003251 93003951 93002251 + 93002053</p>	<p>transparent cable/m 3x 1.5mm²</p>  <p>93002152</p>	<p>transparent cable/m 5x 1.5mm²</p>  <p>93002252</p>	<p>hole for power supply</p>  <p>93000100 <b>new</b></p>
<p>connection 135°</p>  <p>93270055</p>	<p>connection 90°</p>  <p>93270060</p>	<p><b>Endplates &gt;</b></p>	<p>endplate</p>  <p>93270181 93270181 + 93270188</p>				
<p>wall support</p>  <p>93270160</p>	<p><b>Fixation/ Mounting &gt;</b></p>	<p>hinged suspension 4m</p>  <p>93000147 93009147 93000147 + 93000149</p>	<p>suspension set 4m</p>  <p>93000150 93000150 + 93000158</p>				
<p><b>Electrical supply &gt;</b></p>	<p>connection box</p>  <p>93000151 93003351 93000951 93000151 + 93000153</p>	<p>flexible</p>  <p>1m 93000152 /m 93000252</p>	<p>power feed tube 1m</p>  <p>93000156 93003156 93000956 93000156 + 93000157</p>				
<p>power feed tube/m</p>  <p>93000256 93003256 93000956 93000256 + 93000157</p>	<p>power feed kit 2m (transparent cable) 3x 1.5mm² alu</p>  <p>93002003 93003203 93002903 93002003 + 93002053</p>	<p>power feed kit 2m (transparent cable) 5x 1.5mm² alu</p>  <p>93002005 93003205 93002905 93002005 + 93002053</p>	<p>connection box for transparent cable 3x 1.5mm² alu</p>  <p>93002151 93003151 93002951 93002151 + 93002053</p>				

### Halfpipe Linear custom made modules

FLUORESCENT

#### TL5 HE fuse down

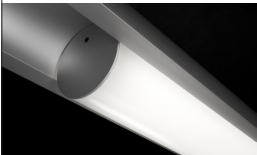

	non-dim	1-10V	DSI	Pushdim/Dali	emergency pack 3h	mod / asym / sym
1x 14W	93275713	96275713	97275713	98275713	-	600/600/600
1x 21W	93275720	96275720	97275720	98275720	93271011	900/900/900
1x 28W	93275727	96275727	97275727	98275727	93271011	1200/1200/1200
1x 35W	93275734	96275734	97275734	98275734	93271011	1500/1500/1500
2x 14W	93275714	96275714	97275714	98275714	-	600/600/600
2x 21W	93275721	96275721	97275721	98275721	93271011	900/900/900
2x 28W	93275728	96275728	97275728	98275728	93271011	1200/1200/1200
2x 35W	93275735	96275735	97275735	98275735	93271011	1500/1500/1500

eco ral ... +93270188 x2

#### TL5 HO fuse down

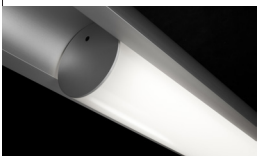

	non-dim	1-10V	DSI	Pushdim/Dali	emergency pack 3h	mod / asym / sym
1x 24W	93275723	96275723	97275723	98275723	-	600/600/600
1x 39W	93275736	96275736	97275736	98275736	93271012	900/900/900
1x 54W	93275751	96275751	97275751	98275751	93271012	1200/1200/1200
1x 49W	93275748	96275748	97275748	98275748	-	1500/1500/1500
2x 24W	93275722	96275722	97275722	98275722	-	600/600/600
2x 39W	93275737	96275737	97275737	98275737	93271012	900/900/900
2x 54W	93275752	96275752	97275752	98275752	93271012	1200/1200/1200
2x 49W	93275749	96275749	97275749	98275749	-	1500/1500/1500

eco ral ... +93270188 x2

T16 G5

h down 75

#### TL5 HE fuse 1/2 out down



	non-dim	1-10V	DSI	Pushdim/Dali	emergency pack 3h	mod / asym / sym
1x 14W	93275813	96275813	97275813	98275813	-	600/600/600
1x 21W	93275820	96275820	97275820	98275820	93271011	900/900/900
1x 28W	93275827	96275827	97275827	98275827	93271011	1200/1200/1200
1x 35W	93275834	96275834	97275834	98275834	93271011	1500/1500/1500
2x 14W	93275814	96275814	97275814	98275814	-	600/600/600
2x 21W	93275821	96275821	97275821	98275821	93271011	900/900/900
2x 28W	93275828	96275828	97275828	98275828	93271011	1200/1200/1200
2x 35W	93275835	96275835	97275835	98275835	93271011	1500/1500/1500

eco ral ... +93270188 x2

T16 G5

h down 75

### Halfpipe Linear custom made modules

#### TL5 HO fuse 1/2 out down



	non-dim	1-10V	DSI	Pushdim/Dali	emergency pack 3h	mod / asym / sym
1x 24W	93275823	96275823	97275823	98275823	-	600/600/600
1x 39W	93275838	96275838	97275838	98275838	93271012	900/900/900
1x 54W	93275853	96275853	97275853	98275853	93271012	1200/1200/1200
1x 49W	93275848	96275848	97275848	98275848	-	1500/1500/1500
2x 24W	93275824	96275824	97275824	98275824	-	600/600/600
2x 39W	93275839	96275839	97275839	98275839	93271012	900/900/900
2x 54W	93275854	96275854	97275854	98275854	93271012	1200/1200/1200
2x 49W	93275849	96275849	97275849	98275849	-	1500/1500/1500

eco ral ... +93270188 x2

T16 G5

h down 75

#### Modupoint EQ unit down

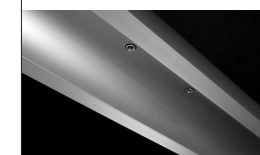

	Dim R, L, C	Dali	mod / asym / sym
1x 50W	93270502	98270502	60/185/310
2x 50W	93270254	98270254	260/260/260

! to be used with Bolster jack - see p.159

#### CDMR 111 bolster down chrome

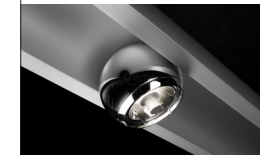

	non-dim	mod / asym / sym
1x 35W	93273137	160/280/360
1x 70W	93273172	160/280/360
2x 35W	93273237	360/560/560
2x 70W	93273272	360/560/560

HIPAR 111 Gx8.5

h 359° v 90°

h down 50

#### CDMR 111 bolster down white struc



	non-dim	mod / asym / sym
1x 35W	93273135	160/280/360
1x 70W	93273170	160/280/360
2x 35W	93273235	360/560/560
2x 70W	93273270	360/560/560

HIPAR 111 Gx8.5

h 359° v 90°

h down 50

#### CDMR 111 bolster down black struc



	non-dim	mod / asym / sym
1x 35W	93273136	160/280/360
1x 70W	93273171	160/280/360
2x 35W	93273236	360/560/560
2x 70W	93273271	360/560/560

HIPAR 111 Gx8.5

h 359° v 90°

h down 50

HALOGEN 12V

DISCHARGE

DISCHARGE

## Halfpipe Supplements



article **ral supplements**  
93278050 ral set up charge



article **supplements**  
93273000 suppl. extra circuit /m



HALFPIPE  
DIA ARCHITECTEN  
OPUZ, HASSELT (BE)



HALFPIPE  
D+Z ARCHITECTEN+PROJECTMANAGERS  
WERELDHAVE, SCHIPHOL (NL)