

SL mini poly out

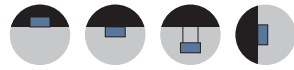

SL MINI POLY OUT
CALLANT, DOMEIN DE CELLEN, OOSTKAMP (BE)



SL MINI POLY OUT ALU



Cross-section / mounting

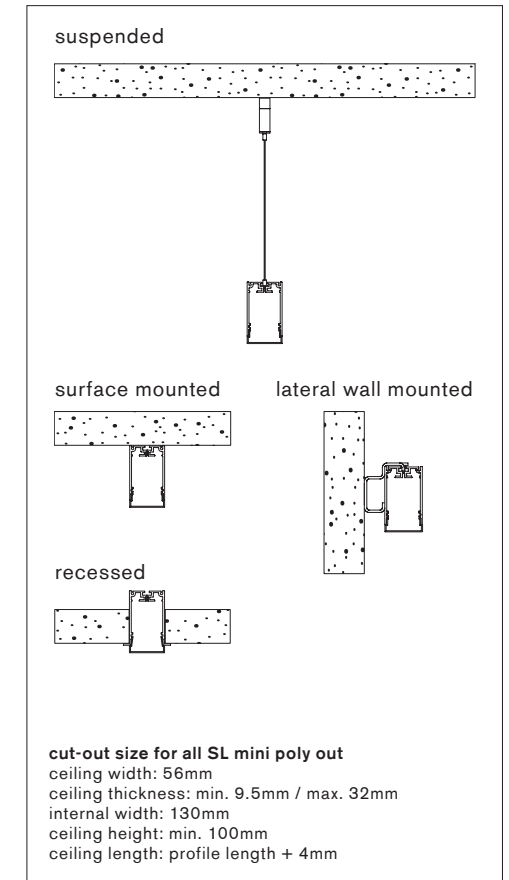
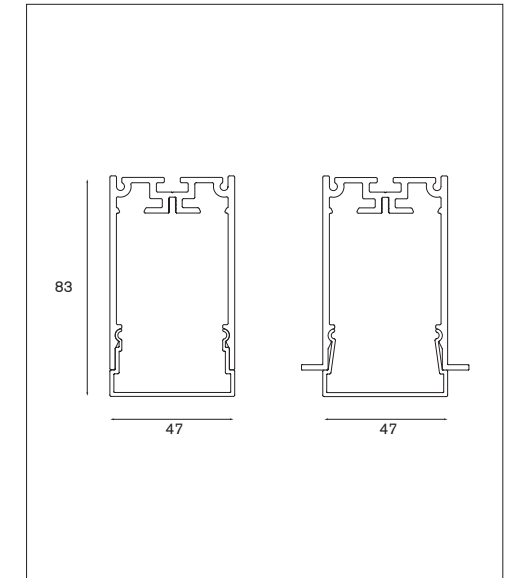

SL mini poly out Ready made

FLUORESCENT

TL5 continuous down GI (length 1207 mm)



surface mounted	non-dim	length*
alu	93420010	1207
black struc	93420011	1207
white struc	93420012	1207

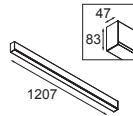

suspended	non-dim	length*
alu	93420020	1207
black struc	93420021	1207
white struc	93420022	1207

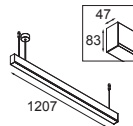

! incl. power feed kit 2m (transparant cable) & suspension set

lampinfo

1x T16 G5	28/54W	54W	down
-----------	--------	-----	------



TL5 continuous down GI (length 1793 mm)



surface mounted	non-dim	length*
alu	93421010	1793
black struc	93421011	1793
white struc	93421012	1793

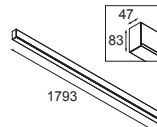

suspended	non-dim	length*
alu	93421020	1793
black struc	93421021	1793
white struc	93421022	1793

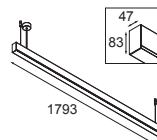

! incl. power feed kit 2m (transparant cable) & suspension set

lampinfo

2x T16 G5	21/39W	39W	down
-----------	--------	-----	------















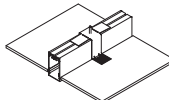
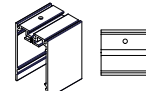
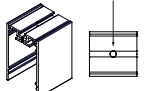
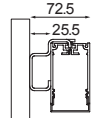
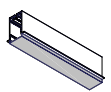
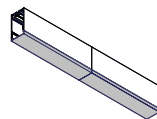
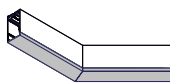

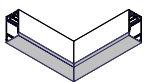
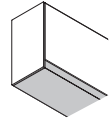
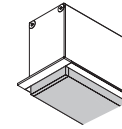

* length including endplates

FLUORESCENT

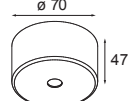
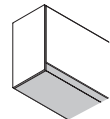
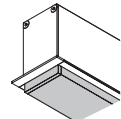

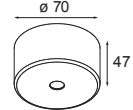
READY MADE PROFILES
 SHORTER LEADTIME. COST SAVING UP TO 20%*.
*compared to linear custom made profiles

SL mini poly out Components

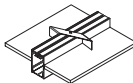
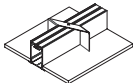
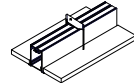
<p>Profile Variation ></p>	<p>profile alu, poly in/m</p>  <p>93420001 93420901 93420001 + 93400010</p>	<p>flange profile alu, poly in/m</p>  <p>93420023 93420923 93420023 + 93400010</p>	<p>profile alu, poly in PMMA/m</p>  <p>93420003 93420903 93420003 + 93400010</p>	<p>trimless bracket</p>  <p>93400997 ! not for TL5/SLS 14/24W</p>	<p>surface fixation hole for LED</p>  <p>93401162</p>	<p>surface fixation hole</p>  <p>hole $\phi 6.5$</p> <p>93000999</p>	<p>lateral wall bracket</p>  <p>72.5 25.5</p> <p>93400161 93400961 93400161 + 93400162</p>												
<p>flange profile alu, poly in PMMA/m</p>  <p>93420024 93420924 93420024 + 93400010</p>	<p>Connections ></p>	<p>connection 180°</p>  <p>93400050</p>	<p>connection 135°</p>  <p>93400055</p>	<p>Electrical supply ></p>	<p>connection box</p>  <p>$\phi 75$ 120</p> <p>93000151 93003351 93000951 93000151 + 93000153</p>	<p>flexible</p>  <p>$\phi 20$</p> <p>1m 93000152 /m 93000252</p>	<p>power feed tube 1m</p>  <p>$\phi 20$</p> <p>93000156 93003156 93000856 93000156 + 93000157</p>												
<p>connection 90°</p>  <p>93400060</p>	<p>Endplates ></p>	<p>endplate surface poly out (with inner poly)</p>  <p>93420183 93420983 93420183 + 93400188</p>	<p>endplate flange poly out (with inner poly)</p>  <p>93420182 93420982 93420182 + 93400188</p>	<p>power feed tube/m</p>  <p>$\phi 20$</p> <p>93000256 93003256 93000956 93000256 + 93000157</p>	<p>power feed kit 2m (transparent cable) 3x 1.5mm² alu</p>  <p>$\phi 70$ 147</p> <p>93002003 93003203 93002903 93002003 + 93002053</p>	<p>power feed kit 2m (transparent cable) 5x 1.5mm² alu</p>  <p>$\phi 70$ 147</p> <p>93002005 93003205 93002905 93002005 + 93002053</p>	<p>connection box for transparent cable 3x 1.5mm² alu</p>  <p>$\phi 70$ 47</p> <p>93002151 93003151 93002951 93002151 + 93002053</p>												
<p>endplate surface poly out</p>  <p>93420184 93420984 93420184 + 93400188</p>	<p>endplate flange poly out</p>  <p>93420185 93420985 93420185 + 93400188</p>	<p>Fixation/ Mounting ></p>	<p>hinged suspension 4m</p>  <p>93000147 93009147 93000147 + 93000149</p>	<p>connection box for transparent cable 5x 1.5mm² alu</p>  <p>$\phi 70$ 47</p> <p>93002251 93003251 93003951 93002251 + 93002053</p>	<p>transparent cable/m 3x 1.5mm²</p>  <p>93002152</p>	<p>transparent cable/m 5x 1.5mm²</p>  <p>93002252</p>													
<p>suspension 4m</p>  <p>93000350 93000950 93000350 + 93000158</p>	<p>suspension bracket small</p>  <p>93400998 ! not for flange profile</p>	<p>suspension bracket large</p>  <p>93400999</p>	<p>suspension bracket asym for LED-strip 5m</p>  <p>93400994</p>	<p>SL mini poly out Supplements</p> <table border="1"> <tr> <td>ral</td> <td>article</td> <td>ral supplements</td> <td>+</td> <td>article</td> <td>supplements</td> </tr> <tr> <td></td> <td>93408050</td> <td>ral setup charge (except white struc and black struc)</td> <td></td> <td>93402000</td> <td>suppl. extra circuit /m</td> </tr> </table>				ral	article	ral supplements	+	article	supplements		93408050	ral setup charge (except white struc and black struc)		93402000	suppl. extra circuit /m
ral	article	ral supplements	+	article	supplements														
	93408050	ral setup charge (except white struc and black struc)		93402000	suppl. extra circuit /m														

SL mini poly out Linear custom made modules

LED

Fortimo LED Line 3850lm/m GI

	3000K non-dim	3000K 1-10V	3000K Pushdim/Dali	mod
2x	93424002	96424002	98424002	562
3x	93424003	96424003	98424003	843
4x	93424004	96424004	98424004	1124
5x	93424005	96424005	98424005	1405
6x	93424006	96424006	98424006	1686
7x	93424007	96424007	98424007	1967
8x	93424008	96424008	98424008	2248

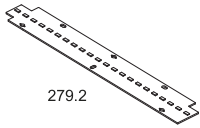

279.2

! gear included
! 1 strip = 8.1W
! 4000K on request

! in combination with standard poly: 58l/W
! in combination with poly PMMA: 71lm/W

eco

LED-strip 700lm/m 24V GE

	3000K
not mounted roll 5m	93000530
mounted/m	93000531
24V connection	93410532

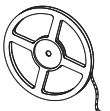

! order LED-strip driver separately - see p.45
! 5m roll - 24V DC - 42.5W/roll - 8.5W/m - 48LED/m - to cut every 12.4cm

new **eco**

LED-strip 1000lm/m 24V GE

	3000K
not mounted roll 5m	93000500
mounted/m	93000501
24V connection	93401502

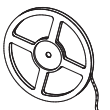

! order LED-strip driver separately - see p.45
! 5m roll - 24V DC - 70W/roll - 14W/m - 60LED/m - to cut every 10cm

eco

LED-strip RGB 24V GE (on request)

	RGB
not mounted roll 5m	93000610
mounted/m	93000611
24V connection	93401612

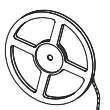

! order LED-strip driver separately - see p.45
! 5m roll - 24V DC - 42.5W/roll - 8.5W/m - 36LED/m - to cut every 16.5cm

eco

LED

Gear for LED-strip

Remote gear for LED-strip

		non-dim	1-10V	Pushdim	Dali	DMX	L	B	H
700lm/m 1000lm/m	24V 20W	93009510	/	/	/	/	150	37	25
	24V 60W	93009530	/	/	/	/	241	43	30
	24V 100W	93009540	/	/	/	/	241	43	30
	24V 20W	/	96009510	/	/	/	146	55	19
	24V 80W	/	96009530	/	/	/	250	50	34
	24V 75W	/	/	/	98009530	/	/	/	/
	24V 100W	/	96009540	/	/	/	250	60	39
RGB	24V 60W + DMX controller	/	/	/	/	93900000	530	50	40
	DMX controller	/	/	/	/	93900005	120	50	25
	to be touched RGB DMX control system	/	/	/	/	11690109	/	/	/
	to be touched power supply	/	/	/	/	11690200	/	/	/

! see p.116 to determine max. distance between strip and driver
! 1 separate driver per 5m LED-strip

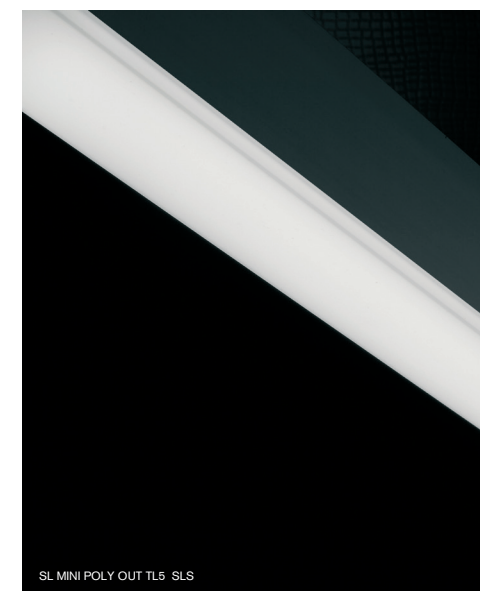

SL mini poly out Linear custom made modules

FLUORESCENT

TL5 SLS continuous line down



	non-dim	1-10V	Pushdim/Dali	emergency pack 3h	mod
1x 14/24W*	93426124	96426124	98426124	-	584
1x 21/39W	93426139	96426139	98426139	-	884
1x 28/54W	93426154	96426154	98426154	-	1184
2x 14/24W*	93426224	96426224	98426224	-	1168
2x 21/39W	93426239	96426239	98426239	-	1768
2x 28/54W	93426254	96426254	98426254	93401112	2368

! check p.98 for TL5 continuous line calculator
! mix of different wattage in the same installation is not allowed due to different luminance

* only for 14W dimmable



T16 SLS G5

TL5 HE continuous line down

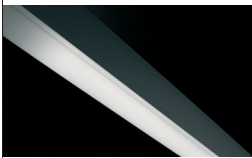

	non-dim	1-10V	DSI	Pushdim/Dali	emergency pack 3h	mod
1x 14W	93425114	96425114	97425114	98425114	-	573
1x 21W	93425121	96425121	97425121	98425121	-	873
1x 28W	93425128	96425128	97425128	98425128	-	1173
1x 35W	93425135	96425135	97425135	98425135	93401012	1473
2x 14W	93425214	96425214	97425214	98425214	-	1146
2x 21W	93425221	96425221	97425221	98425221	-	1746
2x 28W	93425228	96425228	97425228	98425228	93401012	2346
2x 35W	93425235	96425235	97425235	98425235	93401012	2946

! check p.98 for TL5 continuous line calculator



T16 G5

TL5 HO continuous line down

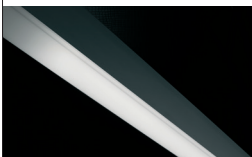

	non-dim	1-10V	DSI	Pushdim/Dali	emergency pack 3h	mod
1x 24W	93425124	96425124	97425124	98425124	-	573
1x 39W	93425139	96425139	97425139	98425139	-	873
1x 49W	93425149	96425149	97425149	98425149	93401012	1473
1x 54W	93425154	96425154	97425154	98425154	-	1173
2x 24W	93425224	96425224	97425224	98425224	-	1146
2x 39W	93425239	96425239	97425239	98425239	-	1746
2x 49W	93425249	96425249	97425249	98425249	93401012	2946
2x 54W	93425254	96425254	97425254	98425254	93401012	2346

! check p.98 for TL5 continuous line calculator



T16 G5

FLUORESCENT

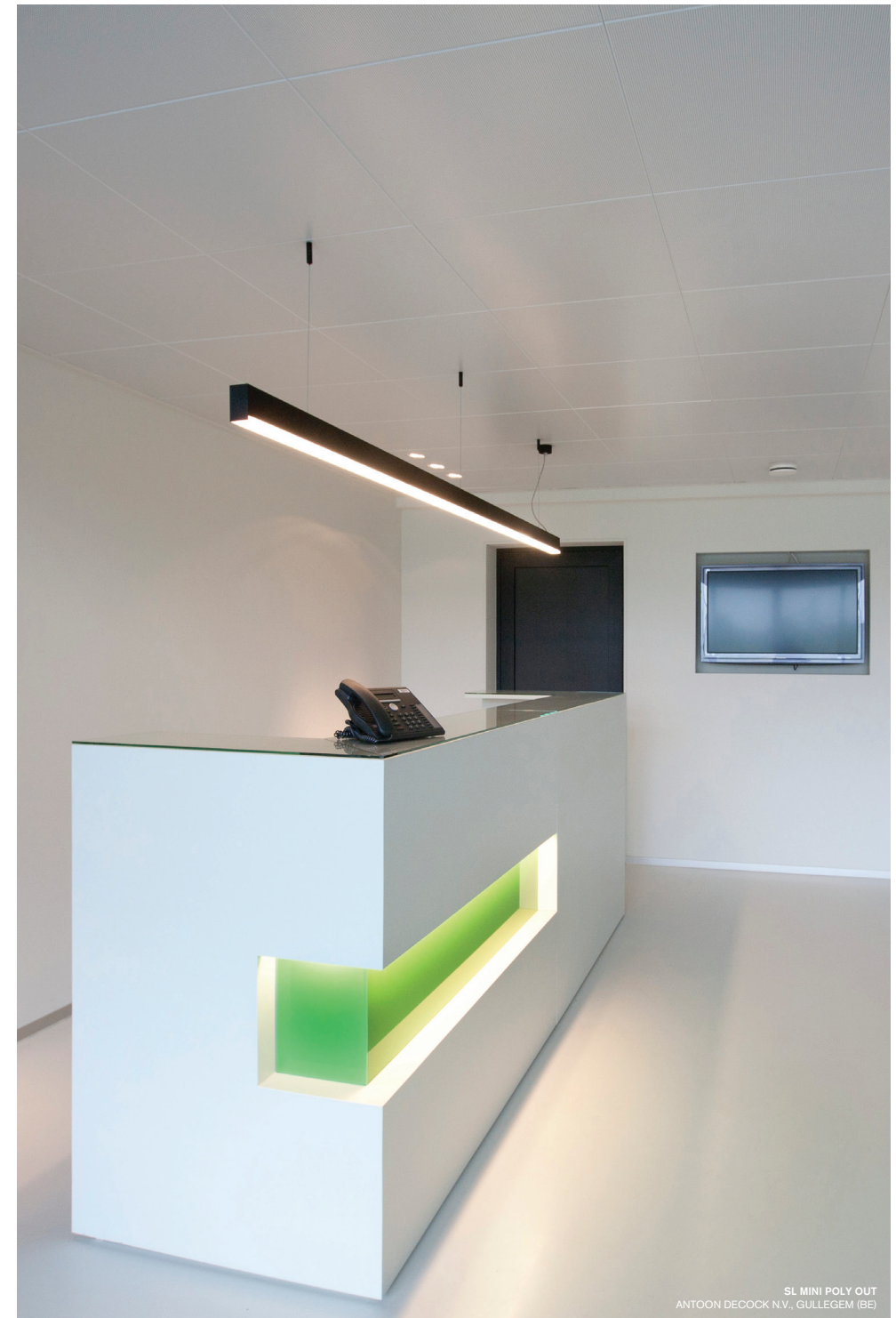

SL MINI POLY OUT
ANTOON DECOCK N.V., GULLEGEM (BE)